

LA-7619-P

Proposal

C.3

CIC-14 REPORT COLLECTION

REPRODUCTION
COPY

Advanced Laser Fusion Target Fabrication Research and Development Proposal

University of California

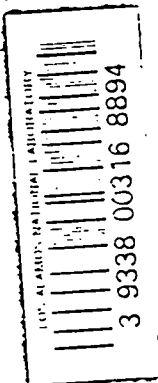

LOS ALAMOS SCIENTIFIC LABORATORY

Post Office Box 1663 Los Alamos, New Mexico 87545

This report was prepared as an account of work sponsored by the United States Government. Neither the United States nor the United States Department of Energy, nor any of their employees, nor any of their contractors, subcontractors, or their employees, makes any warranty, express or implied, or assumes any legal liability or responsibility for the accuracy, completeness, or usefulness of any information, apparatus, product, or process disclosed, or represents that its use would not infringe privately owned rights.

LA-7619-P

Proposal

Special Distribution

Issued: May 1979

Advanced Laser Fusion Target Fabrication Research and Development Proposal

D. M. Stupin

R. J. Fries

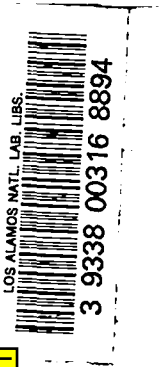

PREFACE

This proposal was written in the spring of 1978 in response to a request from Lieutenant Colonel E. D. Braunschweig, Office of Laser Fusion, US Department of Energy, that we "...suggest the development requirements for those areas that will be needed to support the overall development of ICF [inertial confinement fusion]." In particular, Col. Braunschweig asked us to investigate the problems associated with the fabrication of laser fusion targets in large quantities and to identify the areas in which new technologies must be developed to build a full-production target fabrication facility.

Questions concerning the content of this proposal can be directed to either R. J. Fries or D. M. Stupin at the Los Alamos Scientific Laboratory, Group L-7, Mail Stop 528, Los Alamos, NM 87545 (telephones: 505-667-6461 or 505-667-5980, respectively; FTS telephones: 843-6461 or 843-5980).

ADVANCED LASER FUSION TARGET FABRICATION
RESEARCH AND DEVELOPMENT PROPOSAL

by

D. M. Stupin and R. J. Fries

ABSTRACT

A research and development program is described that will enable the fabrication of 10^6 targets/day for a laser fusion prototype power reactor in 2007. We give personnel and cost estimates for a generalized laser fusion target that requires the development of several new technologies. The total cost of the program between 1979 and 2007 is \$362 million in today's dollars.

I. INTRODUCTION

A research and development program is proposed that will enable the fabrication of laser fusion targets (or pellets) in large quantities for the sequence of experimental facilities leading to, and including, a prototype laser fusion power plant. We estimate the new technologies, and the time and effort for their development, that will be needed to construct a target fabrication facility producing 10^6 targets/day in 2007.

The biggest obstacle to this program is that the design of the target for the prototype power plant has not been defined. We, therefore, assume a generalized target of numerous spherical shells made of any material or no material at all (that is, vacuum). For simplicity, we assume an innermost shell of cryogenic deuterium-tritium (DT) fuel. The entire target fabrication process will be automated, and the capital cost for the pellet fabrication facility (tens of millions of dollars) will be

amortized over years so that the cost per pellet is essentially the cost of materials.

Our proposed target fabrication development program is based on the needs of the sequence of experimental facilities outlined in the nominal risk option in Battelle's "Engineering Development Program Plan for Inertial Confinement Fusion."¹ These facilities and the year they are expected to be operational are as follows.

- SIF (1988) - Systems Integration Facility.
Perform initial pellet injection and guidance experiments with dummy pellets that simulate weight, size, and other ballistic characteristics of the pellets anticipated for use in subsequent facilities. Requires 1 to 10 pellets/s, 100 pellets/day; bare, unfilled microballoons.
- SPTF (1989) - Single-Pulse Target Facility.
Design and develop a commercial target.

Requires a few targets per day. May influence target program by requiring shells of varied materials.

- ETF (1993) - Engineering Test Facility. Develop and confirm reactor cavity concepts. Specific gain not required, but must have yields of a few hundred kilojoules. Requires 1 to 10 pellets/s, 1000 pellets/day; multishelled, cryogenic targets.
- MTF (1997) - Materials Test Facility. Pellet yields not to exceed requirements for ETF. Requires 10^5 to 10^6 pellets/day for 180-day periods.
- PFR (2000) - Pilot Fusion Reactor. Demonstrate engineering feasibility of integrated systems. Requires 10^6 /day of high-yield, but not necessarily economical, pellets.
- PFPP (2007) - Prototype Fusion Power Plant. Demonstrate that pellets will be economical. Requires 10^6 pellets/day.

The SPTF for commercial pellet development will alter the schedule for target fabrication research and development if designs for targets to be used in this facility require shells we do not know how to produce in 1989. Hence, target requirements for this facility may advance the need to produce shells of specific materials.

Figure 1 shows the design, construction, and operational phases of the experimental facilities and the number of targets required for each. Most of the target fabrication techniques required for the PFPP will be needed beforehand either in 1990 for the construction phase of the ETF or in 1995 for the construction phase of the MTF, even though target production may not be economical at these times. The capabilities to produce, respectively, 10^3 and 10^5 modest-yield targets/day at these times are crucial goals in the Target Fabrication Research and Development Program.

In the next two sections we discuss the new technologies required by the program and specific tasks with the estimated support levels and schedules required to complete them.

II. NEW TECHNOLOGIES

Our estimate of the tasks required for this program is based on the developments that must be completed to permit the manufacture of a generalized all-purpose target to be used in the PFPP. This commercial pellet consists of numerous concentric and spherical shells of any combination of solids, liquids, gases, and vacuums where each shell has a surface-roughness and wall-thickness variation smaller than 300 \AA and an asphericity of less than 1%. This multisandwich target is called the "Dagwood" (Fig. 2). However, because a research and

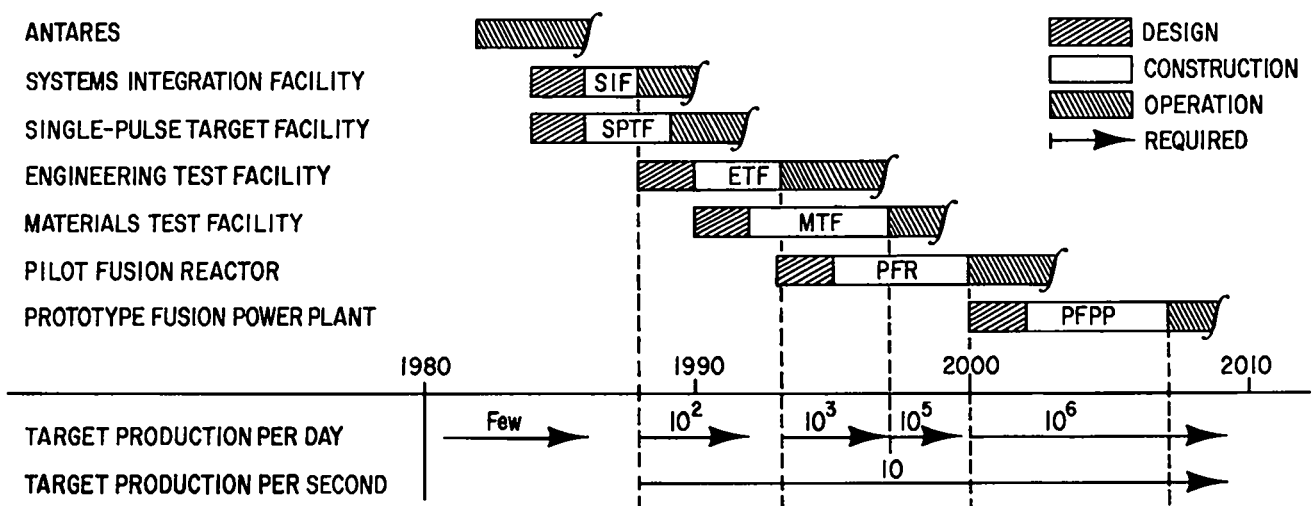

Fig. 1. Requirements for the Advanced Laser Fusion Target Research and Development Program. The time schedule for the facilities outlined in Ref. 1 is shown with the pellet production rates for each facility.

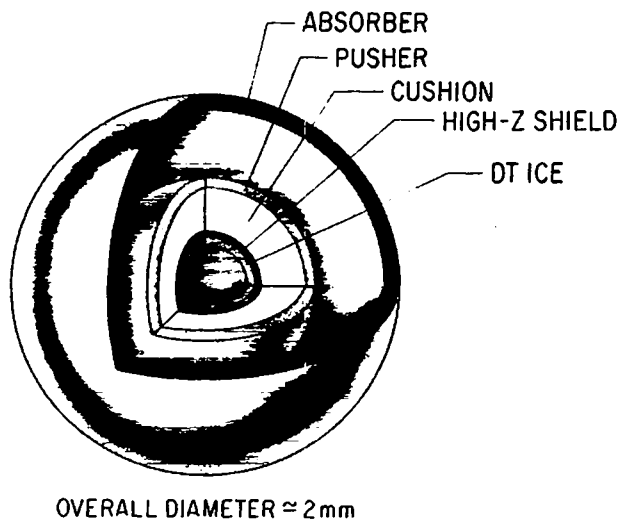

Fig. 2. Example of a Dagwood target with six shells.

development program that would develop the capabilities to build targets out of all these materials is unlikely, the number of prospective materials chosen for these shells must be limited. In other words, as we are keeping the target design as general as possible, we remember that we are limited by our resources and must limit the scope of the program. The limitations we give here must be reevaluated periodically to determine if they are the most logical ones in view of our increasing understanding of the laser fusion process.

We assume that the first shell is DT fuel gas contained by the second shell at room temperature; before the pellet is injected into the fusion reactor vessel, this gas is cooled to cryogenic temperatures to form a uniform layer of DT ice. A method must be found to make the second shell and fill it with the DT gas. Glass as well as plastic microballoons approach the needed surface roughness for these shells, but metal microballoons are of very poor quality and are made of only a limited number of metals. The art of making high-quality free-standing metal microballoons must, therefore, be advanced. Glass and some metal microballoons can be filled with DT by diffusion through their walls at high temperatures and pressures. However, some combinations of wall thickness and material result in such low diffusion coefficients that this method is impractical. For these shells, we must find new

filling methods that do not distort the wall uniformity by more than 300 Å. For example, if a method were developed in which a hole was drilled into a shell, the shell was filled through the hole, and the hole was plugged, the method would be acceptable only if the surface near the plug were distorted by less than 300 Å. In addition, metals that form hydrides cannot be used as DT-gas-containing shells, because hydrides are too brittle to contain gas at high pressures.

For shells outside the innermost two layers,* the easiest ones to fabricate are coatings deposited onto the next inner layer. The coatings that have been suggested for these layers are plastics, plastic foams, metals, metal foams, metal-loaded plastics, and metal-loaded plastic foams. The most difficult shells to make are ice, vacuum, liquid, and gas, because shells that define or contain these layers must be supported and centered. The shells that define these difficult shells are free-standing ones made of the materials suggested above for coatings.

A target with two vacuum layers is shown in Fig. 3, although for the purpose of this discussion, these vacuum layers could also represent either ice, liquid, or gas layers. This target is made by gluing a 100- μm -diam glass microballoon to two 2- μm glass fibers near their intersection and gluing gold and plastic hemishells to the fibers so that they are concentric with the microballoon. A second gold and a second plastic hemisphere must be glued to the fibers to complete the target. With the entire target supported on the glass fibers, the vacuum layers are completed by pumping the target in a vacuum, because the hemishells are glued together only at the fibers and there are vacuum leak paths through the joints between the shells. If either the surface irregularities at the joint of the hemispheres or the mass of the support fibers cannot be tolerated in the commercial pellet then a different method to support these shells must be developed. This problem is particularly difficult if inner shells must be concentrically levitated without any support structure at all.

*The words "shell" and "layer" will be used interchangeably.

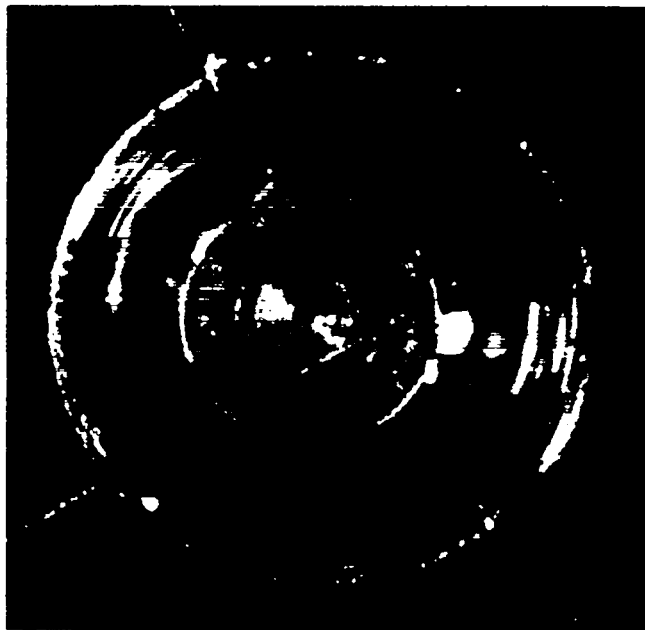

Fig. 3. Six-shell target for Helios. One gold and one plastic hemishell have been removed to show the construction and the DT-filled glass microballoon in the center. Beginning from the center, the shells are: (1) DT ice, (2) glass, (3) vacuum, (4) gold, (5) vacuum, and (6) plastic. The diameter of the largest shell is 0.5 mm.

Furthermore, with gas and liquid shells there are the problems of injecting the material into the shell and containing it, and these problems are acute if different shells require different filling pressures. Combinations of ice and vacuum shells are also difficult to form if the ice layer must be inside the vacuum layer without being separated by an impermeable layer. The difficulty is caused by the fact that the targets are cooled from the outside and the ice layer will, therefore, preferentially condense on the next outer wall. Target fabrication development is required for filling gas and liquid shells, for containing the gases and liquids, and for constructing ice layers that are surrounded by a vacuum layer without an impermeable shell in between. In addition, we have not made targets that consist of a vacuum layer surrounded by an ice, gas, liquid, or impervious layer that would block the leak path used for pumpout. These shell combinations also require target fabrication development.

We will limit the development of coatings and hemispheres of plastics, metals, and foams to a few elements in a wide range of atomic numbers (such as hydrogen, beryllium, boron, carbon, aluminum, silicon, iron, nickel, copper, tungsten, gold, and uranium) to reduce the complexities of these tasks. Some work has been done on appropriate plastic foams, and work is beginning on metal-loaded plastics. But, because of staffing limitations, work has not yet started on either metal foams or metal-loaded plastic foams. Essentially no work has been started on contact-welding techniques to join hemispheres, although some work has been done with glues. Contact welding is vastly superior to glue because it produces a strong bond with a very small surface irregularity, but it requires a substantial development effort.

Once shells are made, their uniformity must be measured. Today, the most sensitive methods for these measurements are optical interferometry for transparent shells and radiography with x rays for opaque ones. Surface finish is best measured with a scanning electron microscope; surface acoustic wave plates look promising for determining shell wall uniformity, as do acoustic microscopes.

Shells in high-yield targets must be uniform² to within $\pm 0.03 \mu\text{m}$ for defects that cover 10 by 10 μm . X-radiographic measurements are sensitive to within $\pm 3\%$ over this area, corresponding to $\pm 0.03 \mu\text{m}$ for 1- μm -thick walls. However, to achieve $\pm 0.03\text{-}\mu\text{m}$ sensitivity for a 50- μm wall, the radiographic method requires a sensitivity of 0.06%, which is two orders of magnitude better than is presently available. This desired sensitivity will be attained with an x-ray source that is 100 times more intense than those available today. For best sensitivity, such a source will be monochromatic in x-ray wavelength.³

At a target production rate of $10^6/\text{day}$ (12/s or 1 every 80 ms), we can imagine a video inspection system that uses 30 ms to record an image and 50 ms to determine the trajectory with computer processing, as well as three or four parameters that can be related to quality, for a total elapsed time of 80 ms. This scenario is feasible today for inspections with light sources but not with x-ray sources. Of course, if more time were required for, say, computer analysis, several inspection lines

could run in parallel. Note too that if the target trajectory needs to be changed, as in a stream entering a reaction vessel, the trajectory change could be done farther down the stream than the inspection process and need not be included in this 80-ms period. For x-ray inspection, this 80-ms scenario will require a more intense x-ray source than the one indicated in the previous paragraph because that estimate assumed a 5-min exposure time. However, some exposure geometries may allow simultaneous inspection of several shells by using all the solid angle of the x-ray flux, thus reducing the intensity requirement. Fast x-ray inspection will also require a video camera that is sensitive to x rays and has good spatial resolution.

A development program is required to measure the shell uniformities with optical and x radiation and, perhaps, with other techniques as well. A measurement system can use the video cameras and computers available today, but a good x-ray video camera and an x-ray source with the desired source size and intensity must be developed. Nevertheless, the x-radiographic and optical-interference methods have severe limitations. For example, the uniformity of an inner shell cannot, in general, be determined if it has a lower atomic number than opaque shells surrounding it (for example, DT ice layers inside metal shells). Hence, work must progress on other methods of measuring shell uniformity. Suggested methods include surface acoustic wave plates for batch processing of freestanding shells (based on Bongianini's work⁴), acoustic microscopes for shell thickness uniformity measurements, and electron microscopes for on-line surface uniformity measurements.

A large effort will be required to automate pellet fabrication. However, there is no conceptual difficulty in automating this process. In the last decade, the microelectronics industry has developed ways to mass produce complicated microcircuits with high precision, and there is no reason why a similar effort could not produce an automated pellet factory. Many coating techniques developed by the electronic industry are directly applicable to pellet fabrication.

Video systems are capable of locating and recognizing objects within the time scales estimated. Therefore, we can imagine a shell made in a batch

process passing down a conveyer belt, being recognized and located by a video system, and being picked up on a vacuum probe. Then the shell is processed, for example by drilling a hole into it, filling it with DT, and plugging the hole. For a target similar to the one in Fig. 3, we can imagine that a hemispherical shell is picked up, two rubber cement fibers are extruded from a nozzle and attached to the shell to form a cross, and a DT-filled shell is placed near the intersection of the fibers, adhering to the fibers on contact. While this assembly is located and held in place, a second hemispherical shell is contact welded to the first to produce a microballoon suspended inside one spherical shell.

An all-cryogenic target that merits special attention was described by Hendricks⁵ at the 1978 Inertial Confinement Fusion Meeting. The concept is a solution to many target fabrication difficulties, but it has not been shown that this target will produce a significant yield. This target consists of many concentric shells of ices of different materials, with an inner shell of DT ice. For example, a three-shell version might consist of a 1-mm-thick, 4-mm-diam DT ice shell coated with 0.4 mm of xenon ice, which, in turn, is coated with 2 mm of H₂ ice (Fig. 4).

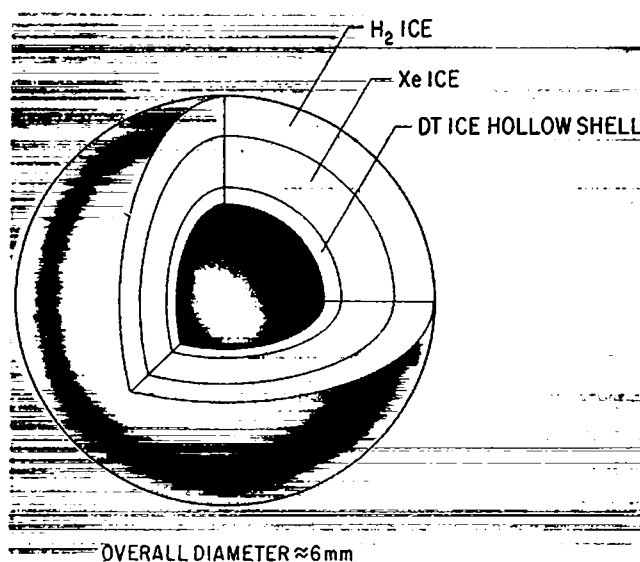

Fig. 4. All-cryogenic target with three layers.

The DT ice shell is made by releasing droplets of liquid DT in a drop tower cooled to a few kelvin, solidifying the liquid into a hollow shell (Fig. 5). This method has been used with moderate success to make hollow H₂ shells.^{6,7} The hollow shells fall through a hole in a baffle into a second chamber in the drop tower, which contains xenon at cryogenic temperatures. The xenon condenses onto the DT shell, and the target passes through another baffle

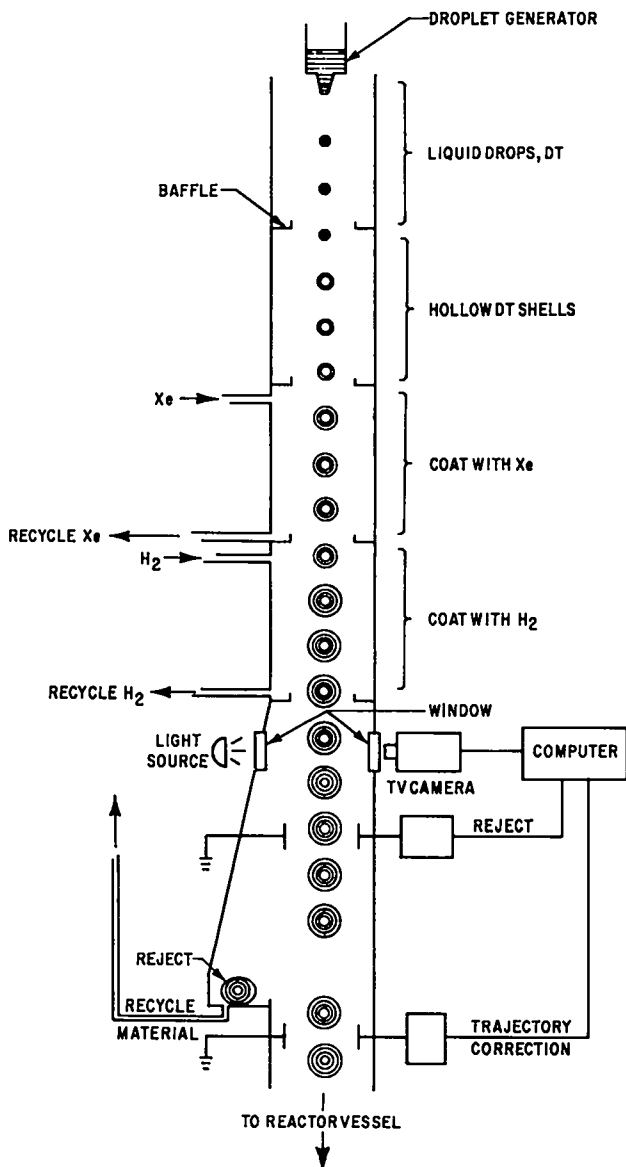

Fig. 5. Drop tower for making special cryogenic targets.

into a third chamber, which contains H₂ at cryogenic temperatures, where the third layer is condensed onto the target. In principle, any number of shells can be added by this method. If this method is to work well, the gas pressure in the drop-tower chamber must be significantly higher than the vapor pressure of the ice, but this will cause ice to build up on the chamber walls. After some time, the ice thickness will inhibit the performance of the drop tower, and the ices will have to be removed. For continuous production, a second drop tower could be placed in operation while the first one is thawed.

In the last chamber of the drop tower, the target is detected with a video system, which determines both the target trajectory and the uniformity of each shell. Unacceptable targets are rejected by deflecting them into a bin from which their materials can be recycled. Targets of good quality, which are in the proper time window to be irradiated by the laser, are deflected to correct their trajectory and are allowed to pass into the reaction vessel. Or, alternatively, their trajectory is fed to a steering apparatus, which aims the laser beam at the falling target.⁸ The all-cryogenic target is a relatively simple solution to many target fabrication problems. If this target can be designed to produce high yields, it could eliminate many difficulties.

One cautionary note: in commercial power plants, it will be important to recycle target materials. For example, if a pellet contained one gold shell, 1 mm in diameter and 0.1 mm thick, then each pellet would contain 6×10^{-3} g of gold, which, at \$200 per ounce, is \$0.05 per pellet. At 10^6 pellets/day, a power plant would thus consume 6×10^3 g of gold per day (\$50 000/day). Although this amount may be economical at first glance, there is not enough gold available to supply many of these plants for many years. A recycling system is obviously needed but has not been included in this proposal.

III. TASK DESCRIPTIONS

In this section, we present by task the estimated personnel and fiscal needs required to complete this Target Fabrication Research and Development Program. Each task is indicated in Fig. 6, and, because each task is keyed to the needs of the

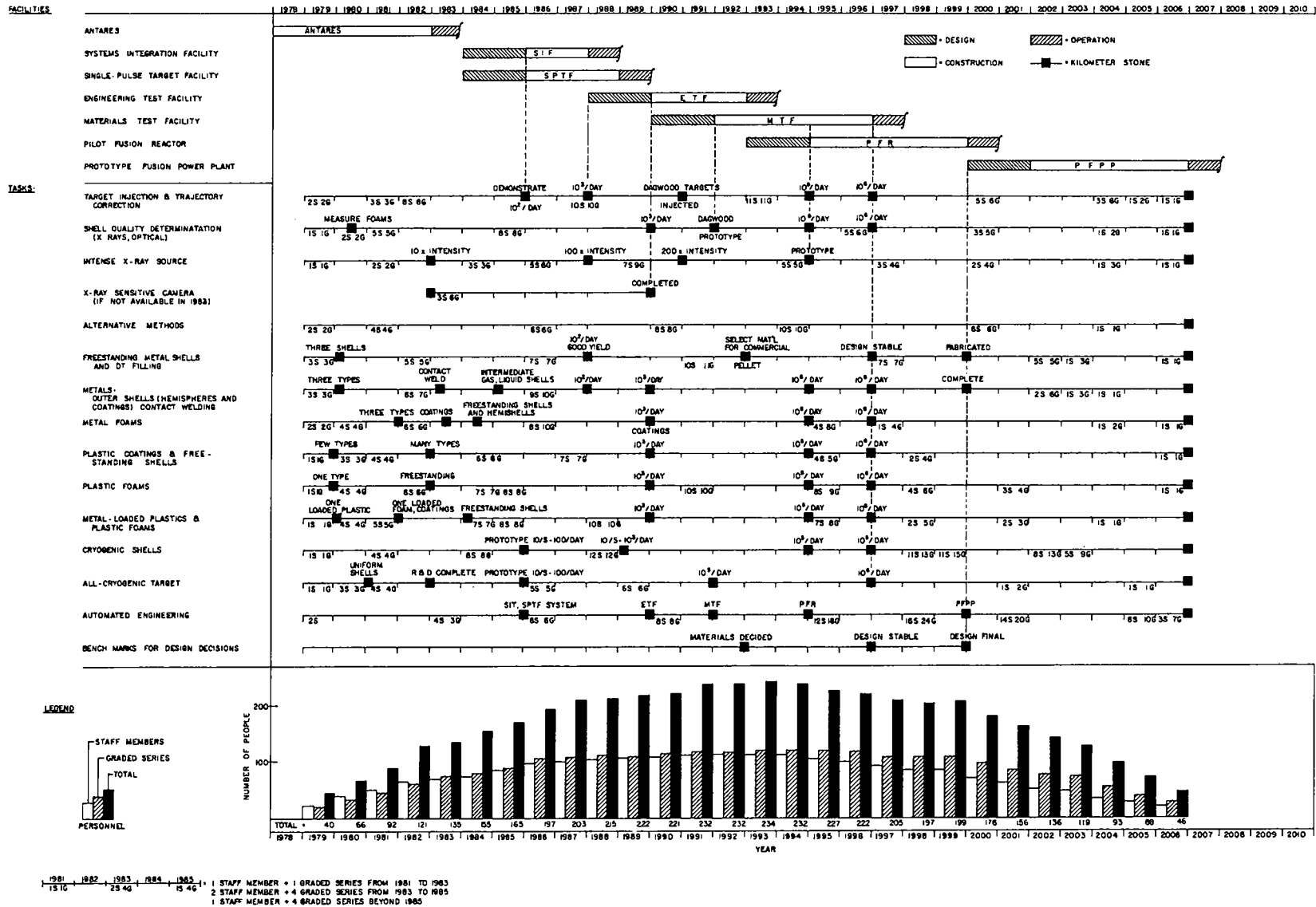

Fig. 6. Personnel requirements by task for the Advanced Laser Fusion Target Research and Development Program.

facilities outlined in the Battelle report,¹ the time schedule for these facilities is also included for direct comparison. Estimated personnel requirements and one or more decision points (kilometer stones) for each task and each year are given, and total personnel requirements for each year are presented graphically in full-time equivalent (FTE) persons. A summary of personnel requirements is also given in Table I, along with the cost of salaries, capital equipment, and materials and supplies for research and development in today's dollars and in 10%/yr inflation-corrected dollars. These estimates are for research and development only and do not include the cost of any buildings or the operation of the pellet factory. We estimate the cost of this 28-yr program to be \$362 million (today's dollars).

The decision points indicate dates at which certain capabilities should be demonstrated. If a

decision point is not met, the program may be lacking in a specific requirement, and a decision must be made either to increase the support level for the deficient task or to abandon that task and choose an alternative method. The decision points do not necessarily coincide with the time when a requirement must be met. Most of them have been advanced so that an operating system can be engineered and built for the experimental facilities after a bread-boarded prototype has demonstrated the operating principles. For example, Fig. 1 indicates 10^5 targets/day for MTF operation but Fig. 6 indicates a decision point of " 10^5 /day" at the midpoint of MTF construction. In this instance, 10^5 /day production must be demonstrated in a prototype target injector in 1995 so that a reliable system can be engineered and built into the MTF in 1997. More is written about these decision points in the task descriptions that follow.

TABLE I
ESTIMATED FTEs and COSTS

Year	Personnel			Cost	
	Staff	Graded	Total	Today's \$ (Million \$)	10%-Inflation Corrected (Million \$)
1979	21	19	40	3.0	3.3
'80	34	32	66	5.0	6.6
'81	47	45	92	6.9	9.2
'82	61	60	121	8.9	13.0
'83	66	69	135	10.0	16.1
'84	76	79	155	11.5	20.3
'85	81	84	165	13.6	26.5
'86	95	102	197	15.6	33.4
'87	98	105	203	16.4	35.2
'88	104	111	215	17.4	45.1
'89	107	115	222	19.1	54.4
'90	108	113	221	19.5	61.3
'91	113	119	232	20.3	69.6
'92	113	119	232	20.3	76.6
'93	114	120	234	18.8	76.8
'94	114	118	232	18.6	85.7
'95	106	121	227	18.2	92.2
'96	103	119	222	17.0	94.6
'97	95	110	205	15.8	96.8
'98	87	110	197	14.6	98.4
'99	87	112	199	14.6	108.1
2000	74	102	176	12.9	105.6
'01	66	90	156	11.0	98.7
'02	54	82	136	10.2	100.3
'03	46	73	119	8.0	87.1
'04	35	58	93	6.3	75.0
'05	25	43	68	4.8	64.2
'06	19	27	46	3.8	54.1
Total				362	1708

The last item in the list of tasks in Fig. 6, "Bench Marks for Design Decisions," indicates the decisions for the design of the commercial target. These decisions were determined by the needs of the other tasks and indicate when particular decisions about the design of the final commercial target must be made so that the pellet factory can be constructed on schedule. Brief descriptions of the tasks and their decision points follow.

A. Target Injection and Trajectory Correction

Develop systems that inject targets into the target chamber and, if necessary, guide the target or aim the laser beam so that the targets will be irradiated.

A prototype of an operating injection and guidance system must be demonstrated in 1986 at the beginning of SIF construction so that an operating target injection system can be ready when SIF begins operation. This system must inject 100 bare microballoons/day at rates of up to 10/s into the SIF target chamber. In 1988, at the beginning of the ETF design phase, a prototype must be demonstrated that can inject 10^3 bare microballoons/day into a target chamber. Even though this capability is not required until the ETF begins operation in 1993, experience with the SIF systems will help in reaching this injection rate. This early kilometer stone will allow time to engineer and build an injector based on this prototype.

Injection systems for cryogenic targets are more difficult to build because cryogenic shells are destroyed in a few milliseconds when exposed to a room-temperature environment. Thus, much of the target injection system for cryogenic targets must also be cooled to cryogenic temperatures. An operating prototype of a system to inject 10^3 /day of Dagwood targets into a target chamber must be demonstrated in 1991, in time to construct a reliable system for ETF operation. Systems for injecting 10^5 /day and 10^6 /day of Dagwood targets must be demonstrated in 1995 and 1997, respectively, for MTF needs. Because reliable target injecting systems will need to be integrated completely into the PFPP, the 10^6 /day operating model must also be demonstrated before the design phase of this facility.

B. Shell Quality Determination

Measure wall-thickness uniformity and surface finish of each shell in the target to within $\pm 300 \text{ \AA}$ and the sphericity to within $\pm 1\%$.

Optical and x-ray techniques must be developed to measure target quality. A method to measure wall-thickness uniformity of inner shells contained in shells of higher atomic number (for example, DT ice in a metal shell) must be invented. Existing methods must be modified to allow inspection of targets at rates in excess of 10^6 /day. However, note that the rate at which targets must be inspected for quality depends on the yield of the manufacturing processes. For example, if the yield is low, then each target must be examined individually, and the inspection rate must equal the total (good plus bad) target production rate. But if the yield is very high, only randomly selected targets need to be inspected for quality to determine the quality of the target batch.

Uniformity measurements of plastic foam shells must be demonstrated in 1980 for Helios targets. This task may be easy if the plastic foam fills the space between two thin metal shells in such a way that x radiography can measure the separation distance between the metal shells. However, both free-standing and glued-hemisphere plastic foam shells are difficult to measure.

Although the capability to measure the quality of shells in Dagwood targets will be required as early as 1979 for the Helios experimental program, large numbers of these targets are not needed until 1993 for ETF operation. To meet this latter requirement, an operating system must be demonstrated in 1990 that will measure enough cryogenic targets to produce 10^3 /day of good quality. The targets used in this demonstration do not need to be the ones expected for the ETF, but the capability of the inspection system should be adaptable to ETF targets; a prototype inspection system for ETF targets must be demonstrated in 1992. Prototype inspection systems that allow the production of 10^5 and 10^6 good Dagwood pellets/day for PFR and PFPP must be demonstrated in 1995 and 1997, respectively. The next three tasks are related to quality determination but require additional funds.

C. Intense X-Ray Source

Develop an x-ray source that will allow the inspection of 10^6 Dagwood targets/day.

For the shell quality determination task to succeed, an intense x-ray source must be developed. The x-ray energy spectrum must be monoenergetic, and the x rays must be emitted from a small spot if the x-ray inspection system is to have the best sensitivity to wall-thickness variations.³ This task must demonstrate in 1983, 1988, and 1991, respectively, sources of 10, 100, and 200 times higher intensities than those available today. These intensities will permit the measurement of the uniformity of some shells to within $\pm 0.06\%$ at the rates required if a 2π emission geometry about the source can be used. For the small shells used today, the x-ray source size is also small (about 3 mm^2). However, if shells of larger diameter are needed, the source size can become larger, thus decreasing somewhat the difficulty of making the x-ray source. This source must be ready in 1995 for the demonstration of the prototype x-ray inspection system required for the MTF pellet factory.

D. X-Ray Sensitive Camera

Develop a video camera that is sensitive to x rays for the x-ray inspection systems.

If a video camera with a solid-state sensor that is sensitive to x rays and has good spatial resolution is not available in 1983, then one must be developed, preferably by an integrated circuit manufacturer. However, such manufacturers are generally not interested in development projects unless they may result in millions of dollars of sales. Therefore, the device will have to be very marketable. A charge-coupled array consisting of 500 by 500 elements each measuring $5 \mu\text{m}$ on a side, available in 1990, is envisioned.

E. Alternative Methods

Develop other methods for quality selection.

Quality inspection methods that we use today will not meet all our needs for pellet fabrication, and other methods must be developed. Suggestions include surface acoustic wave plates, acoustic

microscopes, and advanced electron microscopes. Methods developed in this task will draw support away from the three previous tasks if a new method is more promising.

F. Freestanding Metal Shells and DT Filling

Develop methods to make high-quality, freestanding metal shells strong enough to contain required pressures of DT or other gases.

Methods to produce freestanding metal shells to contain DT at high pressure and methods to fill them with DT must be developed. Good quality shells filled with DT made of at least three materials - one each of low, medium, and high atomic number - are required for Helios targets in 1979 and 1980. In subsequent years, we must learn how to produce these shells in large quantities with high quality and good yield. For the Helios and Antares targets, only a few shells per day will be required, and it will be sufficient to select the few good shells from a large batch. However, when even 100 targets/day are required, the yield of good shells in batch must be better to reduce the time required for selection. Even though we may find three materials from which to produce freestanding shells in 1980 when 10 shells/day are required, these original three shells may be difficult to produce in quantities of 10^6 /day. Therefore, it may be necessary to continue development of methods to produce freestanding shells of other materials that will be easier to produce in quantity.

Many techniques applicable for shells of one material will not work for those of another; they may not work even if the same material is used to make a shell of a different thickness. Hence, changes in material and thickness in the commercial pellet design may require substantial additional target fabrication developments. Any variations of the commercial pellet design must be severely restricted as the design phase of the PFPP approaches to ensure that the proper shells are available when needed. Thus, the materials to be used in the commercial target must be selected by 1993. By 1997, the shells and their thicknesses must be determined, although small variations in the shell thicknesses may be allowed. These thickness variations, if allowed, will be determined by the manufacturing

processes. By 2000, the design of the commercial pellet must be frozen, and the ability to manufacture the required shells at the required rates must be demonstrated so that the manufacturing process can be integrated into the PFPP pellet factory.

G. Metals: Outer Shells (Hemishells and

Coatings) Contact Welding

Develop both metal hemishells that can be assembled into hollow spheres and metal coatings for shells that are outside the inner two shells.

For shells outside the inner two shells (assumed to be DT and its container), methods to produce metal hemishells and metal coatings must be developed. The metal hemishells will be used in the same way as the gold and plastic hemishells in the target in Fig. 3. A method, such as contact welding, must be devised to join the hemishells. Where an outer metal shell can be deposited onto an inner shell, new metal-coating techniques are needed. Methods to fill intermediate shells outside the innermost DT shell and its container with gases and liquids also need to be developed. A few high-quality coatings and hemishells will be required for Helios and Antares targets in 1980. By 1983 good techniques should have been developed also for contact welding (or its equivalent), and by 1985 methods to fill intermediate shells with gas or liquid will be demonstrated. In 1988 high-quality shells and coatings must be available in quantity, and techniques for smooth contact welds that can be used on 100 targets/day must be developed. Success in this task will allow completion by 1990 of an automated pellet factory that will produce the 10^3 targets/day for ETF and will demonstrate the feasibility of producing 10^6 /day for MTF.

H. Metal Foams

Develop methods to make metal foams.

Low-density metal may be required for the commercial target, and hence, methods must be invented to produce metal foams. Three kinds of metal foams will be available in 1982, and uniform metal-foam coatings for several materials will be available by

1983. An automated system for depositing high-quality metal-foam coatings in quantities of 10^3 /day will be demonstrated in 1990 so that foams can be used in ETF targets. Good-quality free-standing shells and hemishells made of these foams will be available by 1984.

I. Plastic Coatings and Freestanding Shells

Develop methods to produce freestanding plastic shells and plastic coatings.

Plastic shells and coatings are required for Helios and Antares targets; thus, we can expect to be able to produce a few types of plastic shells and coatings of good quality by 1980. By 1983, the ability to make several types of plastic shells and coatings will be developed. After this stage, most of the effort will be directed toward producing quantities of these items with good yield in surface finish and wall-thickness uniformity. Prototype systems for producing 10^3 /day, 10^5 /day, and 10^6 /day should be demonstrated in 1990, 1995, and 1997, respectively, to meet the needs of the ETF and subsequent facilities.

J. Plastic Foams

Develop low-density plastics.

Helios and Antares target designs require low-density plastic foams with small cell size; therefore these foams may be required for the commercial pellet. At least one type of this material will be available in 1980 for use as a coating; freestanding shells, and hemishells that can be joined to form a freestanding shell, will be available in 1983. Because of the unique nature of this material, there may be only one or two types of plastic that can be made with this low density and small pore size. As with the immediately preceding tasks, the rest of this task will be devoted to producing large numbers of high-quality shells and coatings.

K. Metal-Loaded Plastics and Metal-Loaded Plastic Foams

Develop methods to produce coatings and free-standing shells and hemishells of these materials.

The development of metal-loaded plastics and plastic foams will provide low-density materials with high atomic number for target shells. This task must, by necessity, follow developments in the plastic-coatings and plastic-foam tasks, but much of the work can be done in parallel. For example, methods for making metal-loaded plastics can be developed at the same time as methods for making unloaded plastic coatings. One metal-loaded plastic will be demonstrated in 1980, and one metal-loaded plastic foam will be demonstrated in 1982, 2 yr after the low-density plastic development. Also by 1982, uniform coatings of metal-loaded plastics will be available. Uniform coatings of metal-loaded plastic foams with small pore size will be available in 1984 and so will freestanding shells and hemishells of metal-loaded plastic foams. The rest of this task is devoted to producing large numbers of these coatings and shells with uniform wall thicknesses and smooth surfaces.

L. Cryogenic Shells

Develop methods to produce cryogenic layers of DT ice or liquid in Dagwood targets.

Miller's technique⁹ produces the most uniform layer of DT ice inside a bare microballoon; however, no one has produced cryogenic shells in a complex Dagwood target or a target with multiple ice shells, and these capabilities must be invented. To produce cryogenic layers in outer shells, we must develop a method to fill the outer shell and contain the gas. Even targets with a single inner layer of DT ice and several shells of other materials may be difficult to produce with a uniform layer of ice, because no one knows the effects of multiple shells on the ice layer. This task is particularly difficult because exposure of a cryogenic target to room temperature will destroy the DT ice layer in a few milliseconds.

The production of high-quality Dagwood pellets with several shells (but only one ice shell) must be demonstrated in 1986 at production rates of 10 pellets/s and 10^3 /day to support the requirements of the ETF. By 1989 this capability must advance to producing 10^3 pellets/day of multiple-ice-shell Dagwood targets. By 1995 an operating system must

be demonstrated that produces 10^5 Dagwood targets/day for the MTF and shows the feasibility of producing 10^6 pellets/day for the PFPP.

M. All-Cryogenic Target

Develop DT-hollow-shell drop tower and other cryogenic coating techniques.

We are very close to knowing how to make this special all-cryogenic target, which, if it can be shown to have a good energy yield in laser fusion reactions, could solve many of the problems in laser fusion target fabrication. If the energy yield of this target is promising, hollow and uniformly thick shells of DT ice can be demonstrated in 1981 using cryogenic drop tower techniques, and a multiple-shell target with one layer of DT ice and a few layers of other ice materials can be demonstrated in 1983. A prototype of an automated system to produce 10 pellets/s and 100 pellets/day of the multishelled targets can be demonstrated in 1986. Subsequent systems in 1992 and 1997 can be designed to produce 10^5 and 10^6 /day of these targets, respectively.

N. Internal Target Support

Develop methods to support the internal structure of the targets.

Some target designs require an inner shell separated from an outer shell by either a vacuum, gas, or liquid layer. At present, we make vacuum insulation targets by mounting the inner shells on rubber-cement or glass fibers as shown in Fig. 3. But if this method is not suitable for the commercial pellet, other methods will have to be developed. Electrostatic levitation has been suggested as one solution to this problem; there may be others. If support other than the suspended-fiber approach is required, it will have to be added to this Advanced Target Development Program.

O. Automated Engineering

Assimilate all tasks into pellet factories in 1986 for SIT and SPTF, 1990 for ETF, 1992 for MTF, 1995 for PFR, and 2000 for PFPP.

P. Bench Mark For Design Decisions

These decision are determined by the tasks outlined above and determine the design of the commercial pellet.

If the tasks are to proceed in an orderly manner, certain decisions must be made about the commercial pellet as the design period for the PFPP approaches. For example, many coating techniques that are applicable for shells of one material will not work for those of another; they may not work even if the same material is used to make a shell of a different thickness. Hence, at some time before the PFPP is constructed, we must know which shell materials and which thicknesses will be required so that methods to produce these specific shells can be addressed. The dates when this information is required depend on the success of the Target Fabrication Research Program: if the program is very successful, we will be capable of producing targets of any complicated configuration, and the final design for the commercial target can wait until initiation of the PFPP design stage. If, on the other hand, the target development program is not so successful, our capabilities will be limited, and the final pellet design should be chosen rather early.

For the schedule given in Fig. 6, we assumed a modestly successful Target Fabrication Development Program. Therefore, the number of shells and the material for each shell in the commercial pellet must be chosen by 1993. By 1997, the shell thicknesses must be determined, but some variation will be allowed depending on the techniques used to make the shells. By 2000, the target design must be frozen so that a pellet factory can be designed and built for the PFPP. Any detail about the pellet design and manufacture that can be determined beforehand will improve the chances that the pellet factory can be built as scheduled.

IV. SUMMARY

We have presented our best estimates to describe an Advanced Laser Fusion Target Fabrication Research and Development Program that will enable us to fabricate 10^6 targets/day for a prototype laser

fusion power reactor in 2007. Specifically, we have identified tasks and estimated personnel and funding requirements that would lead to a successful program. Our presentation is based on a generalized target design; however, despite the flexibility built into this program, aspects and problems not considered could alter our predictions.

REFERENCES

1. T. L. Willke, D. A. Dingee, L. E. Ault, M. C. Bampton, W. E. Bickford, J. S. Hartman, E. P. Simonen, V. L. Teofilo, and T. G. Frank, "Engineering Development Program Plan for Inertial Confinement Fusion, Vol. II, Program Strategy," Battelle, Pacific Northwest Laboratories report PNL-2582 (March 1978).
2. B. W. Weinstein, "Advanced Target Characterization," in P. E. Coyle, "Laser Program Annual Report-1976," Lawrence Livermore Laboratory report UCRL-50021-76, p. 4-168.
3. R. H. Day, T. L. Elsberry, R. P. Kruger, D. M. Stupin, and R. L. Whitman, "X-Ray Micro-radiography of Laser Fusion Targets," Proc. Int. Conf. X-Ray Opt. Microanal., Boston, August 1977 (Scientific Press, New Jersey, in press), R. E. Ogilvie, Ed.
4. W. L. Bongiani, S. M. Butler, and J. R. Miller, "Batch Processing for Microballoon Fusion Targets," in Inertial Confinement Fusion, Dig. Tech. Pap. Top. Meet., San Diego, California, February 7-9, 1978 (Optical Society of America, Washington, D. C., 1977).
5. C. D. Hendricks, "Production of Power Plant Inertial Confinement Fusion Targets," in Inertial Confinement Fusion, Dig. Tech. Pap. Top. Meet., San Diego, California, February 7-9, 1978 (Optical Society of America, Washington, D. C., 1977).
6. C. A. Foster, C. D. Hendricks, and R. J. Turnbull, "Hollow Hydrogen Spheres for Laser-Fusion Targets," Appl. Phys. Lett. **26**, 580 (1975).
7. R. J. Calliger, R. J. Turnbull, and C. D. Hendricks, "Hollow Drop Production by Injection of Gas Bubbles into a Liquid Jet," Rev. Sci. Instrum. **48**, 846 (1977).
8. M. J. Monsler, "An Assessment of Pellet Injection, Tracking and Optical Focusing and Pointing for Laser Fusion Power Plants," Proc. Technol. of Contr. Nucl. Fusion, American Nuclear Society, Santa Fe, New Mexico, May 1978.
9. J. R. Miller, "A New Method for Producing Cryogenic Laser Fusion Targets," Adv. Cryog. Eng. **23**, 669 (1978).